

Article number: 03552025

Description: Fluro hydraulic rod end FPR 25N

Measures

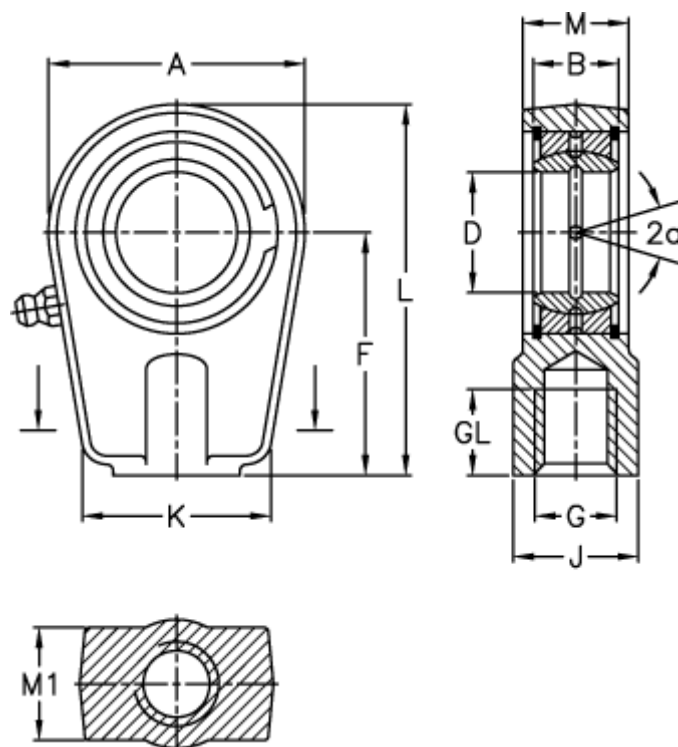

A	= 56	J	= 25
a (degrees)	= 7	K	= 46
B	= 20	L	= 80
D	= 25	M	= 23
Dynamic load C (kN)	= 48	M1	= 21
F	= 50	Static load C0 (kN)	= 72
g	= M16x1,5	Weight	= 475
GL	= 17		